

Vacuum-type cooling system filler

The KVB 01 and KVB 01.1 permit repaired cooling systems to be checked for leaks and refilled free of any air pockets.

To connect the KVB 01 to the cooling system expansion tank, a radiator adapter with connecting nipple is also required (corresponding to vehicle model - see accompanying list of adapters).

The KVB 01.1 is supplied complete with a UA 50 universal adapter.

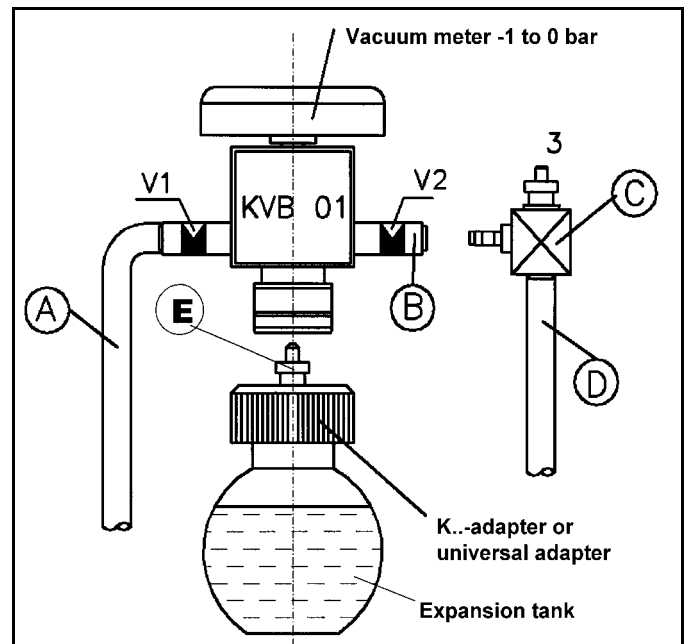

Illustr. 1

Preliminary tasks/requirements

- ▶ *The expansion tank of the cooling system has to be empty.*
- ▶ *Check the capacity of the cooling system (refer to vehicle user's manual).*
- ▶ *A sufficient quantity of coolant complying with the specified quality must be available.*
- ▶ *Compressed air supply at 6-10 bar (87-145 psi).*
- ▶ *It is advisable to work with a container marked with a scale showing coolant level.*
- ▶ *Set the heating control switch (in the vehicle) to the 'high heat' position.*

1. Directions for use

- a) The venturi tube (C) is prepared with a 1/4" interior thread. A suitable nipple (3) must be connected. (see illustr. 2)
- b) Remove radiator cap. Press-fit model-related adapter K.. or screw mount universal adapter UA 50 to the expansion tank filler neck.
- c) Connect KVB 01 at (E). (see illustr. 1)
- d) Take care to ensure that stopcocks V1 and V2 are closed. (see illustr. 3)

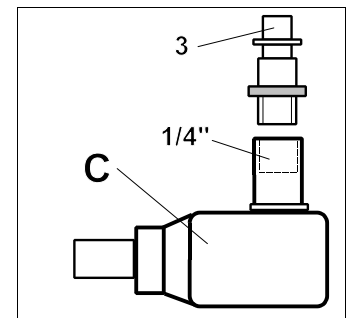

Illustr. 2

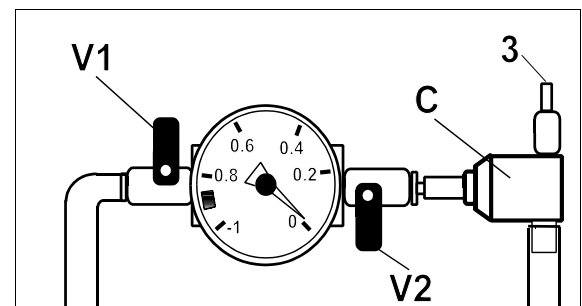

Illustr. 3

- e) Connect venturi tube (C) to KVB 01.
 (see illustr. 4)

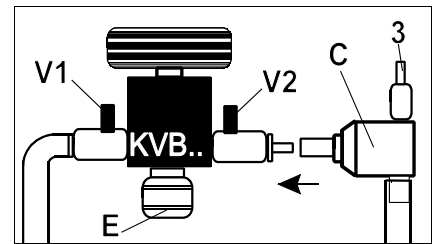

Illustr. 4

- f) Connect nozzle (3) to workshop compressed air supply.
Note:
 The venturi nozzle makes a hissing noise. This is normal.
 (see illustr. 5)

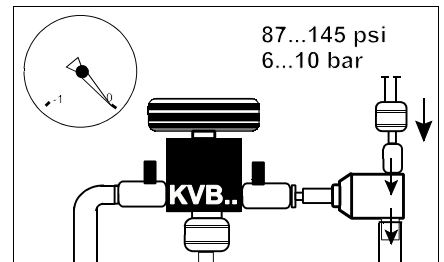

Illustr. 5

- g) - Bleed the filling tube (A).
 - Immerse filling tube (A) in coolant and secure against slipping.
 - Open stopcocks V1 and V2.
 - The filling tube (A) will now fill with coolant.
 - Do not close V1 until the filling tube (A) is free of air pockets.
 - Surplus coolant will be discharged through tube (D).
 Have a container ready to catch this coolant.
 (see illustr. 6+7)

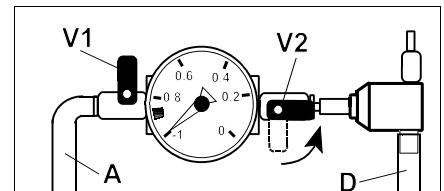

Illustr. 6

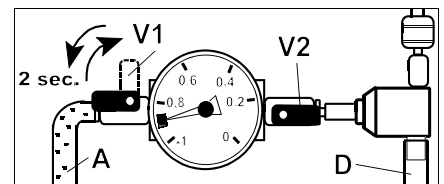

Illustr. 7

2. Evacuation of the cooling circuit

- ▶ The ultimate vacuum is reached at between -0.85 and -0.9 bar (12.3 and 13 psi) (green zone in vacuum meter display). (see illustr. 8)
- ▶ Close stopcock V2.
- ▶ Disconnect compressed air supply from nozzle (3) on venturi tube (C). (see illustr. 9)

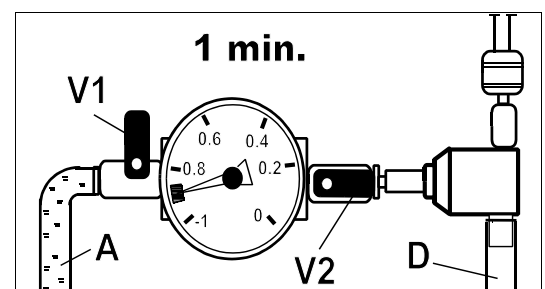

Illustr. 8

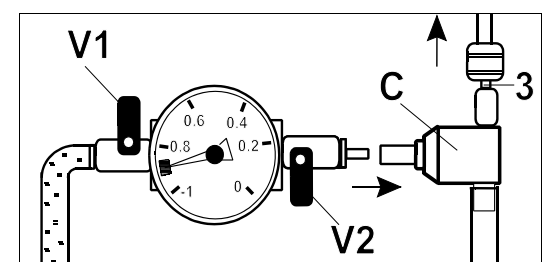

Illustr. 9

3. Leak testing

- ▶ The cooling system will remain under vacuum for 1 minute. If the vacuum falls, this indicates a leak in the

cooling system
 (observe vacuum meter display).

- ▶ If the vacuum remains constant, filling the cooling system can proceed.
 (see illustr. 9)

4. Filling the cooling system

- ▶ Open stopcock **V1**.
 (see illustr. 11)
- ▶ Check the volume of coolant filled or fill the expansion tank up to the max. mark. If residual vacuum is present in the cooling system after filling, it can be released by opening stopcock **V2**.

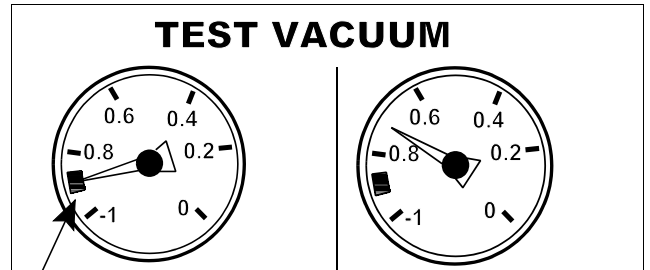

Illustr. 10

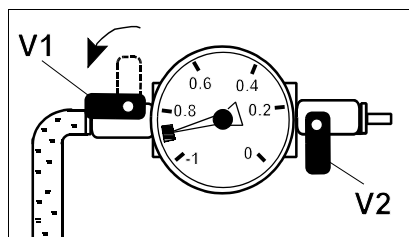

Illustr. 11

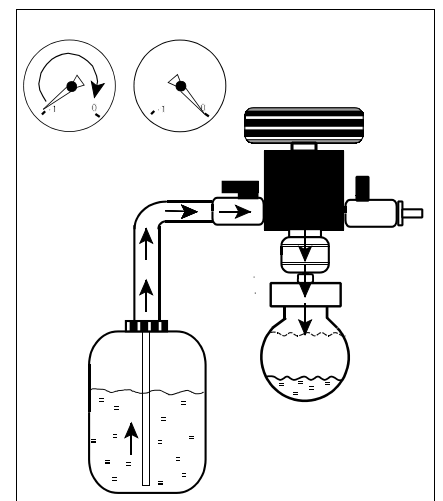

- ▶ Vacuum in the cooling system will result in the related flexible tubes becoming distorted. This may cause the coolant level in the expansion tank to fall. In this case, top up the coolant manually.

Note:

Start the vehicle to bleed the secondary cooling circuit if applicable. This may also cause the coolant level in the expansion tank to fall, in which case top up manually.

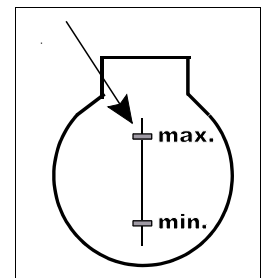

Delivery specification	KVB 01	KVB 01.1	
KVB 01 basic unit with vacuum meter -1 to 0 bar with rubber cap, venturi tube and connecting tubes, boxed	●	●	 UA 50
Universal adapter UA 50		●	